

External documentation

- [Apache HTTP Server Version 2.4 Documentation](#)

Tip

Whenever searching for Apache related documentation *a/ways* include “2.4” in your query: Configuration file syntax changed considerably with respect to Apache version 2.2.

URI to filesystem mapping



URI to filesystem mapping

<https://www.my.org/sub/foo.html>



URI to filesystem mapping

<https://www.my.org/sub/foo.html>

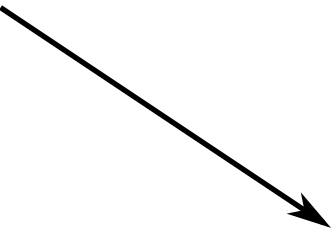

Webserver's filesystem

URI to filesystem mapping

<https://www.my.org/sub/foo.html>

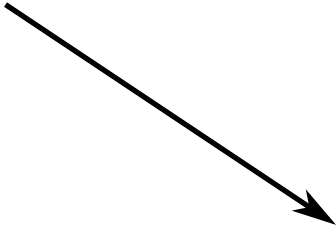

Webserver's filesystem

DocumentRoot `/var/www/html`

URI to filesystem mapping

<https://www.my.org/sub/foo.html>

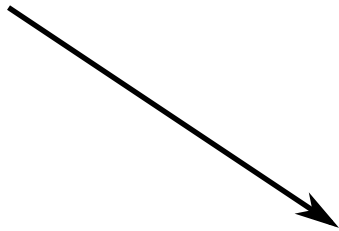

Webserver's filesystem

DocumentRoot `/var/www/html`

`/var/www/html` `/sub/foo.html`

Virtual hosting

- One physical host system
- Serving multiple sites e.g.:
 - `https://www.foo.org`
 - `https://www.second.org`

Implementing virtual hosting

1. Port based virtual hosting
2. IP based virtual hosting
3. Name based virtual hosting

Typically using **S**erver **N**ame **I**ndication (SNI)

IP based virtual hosting



<https://www.second.org>

IP based virtual hosting



DNS

<https://www.second.org>

IP based virtual hosting



IP based virtual hosting



<https://www.second.org>

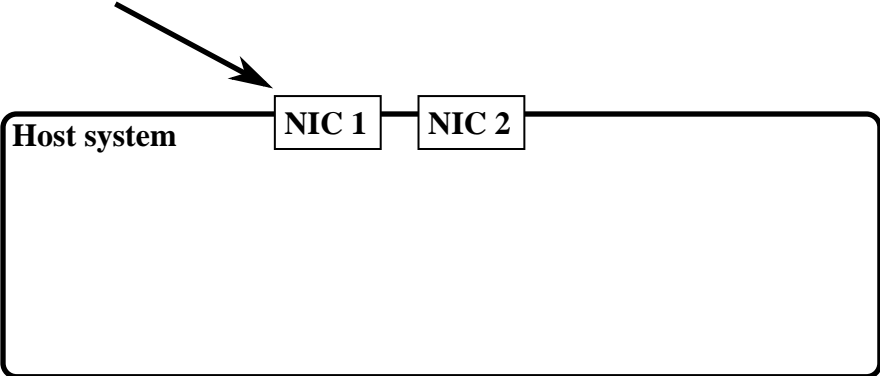

IP based virtual hosting

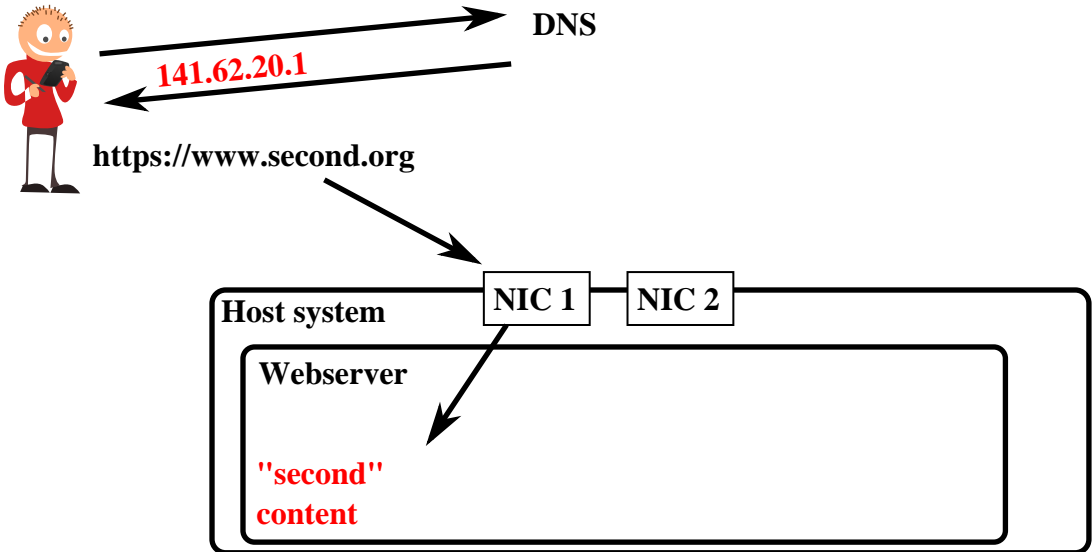

IP based virtual hosting

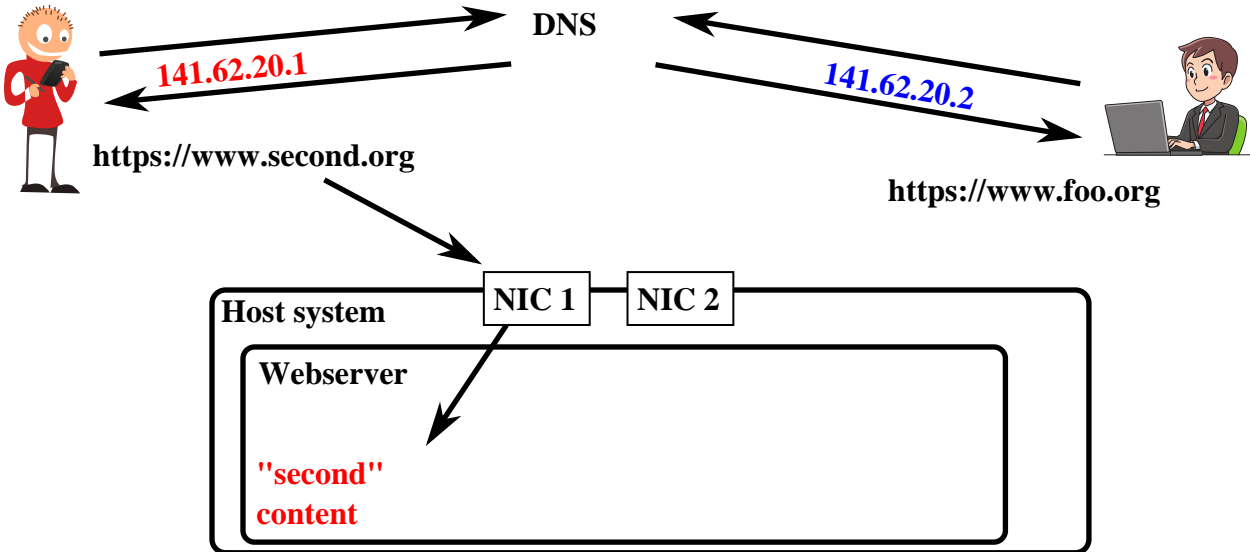

IP based virtual hosting

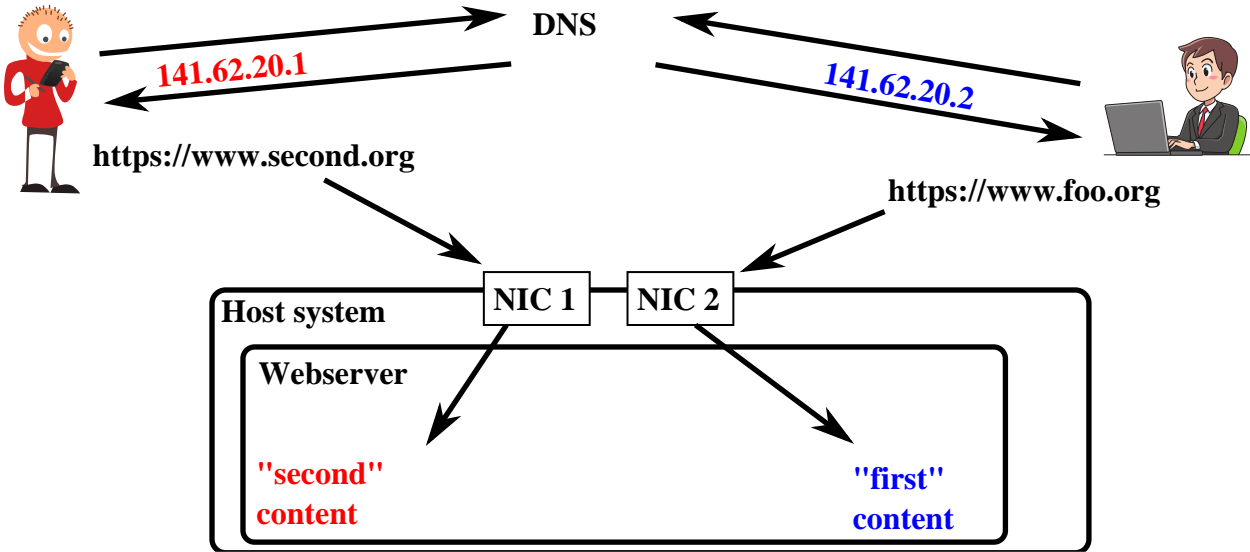

IP based virtual hosting

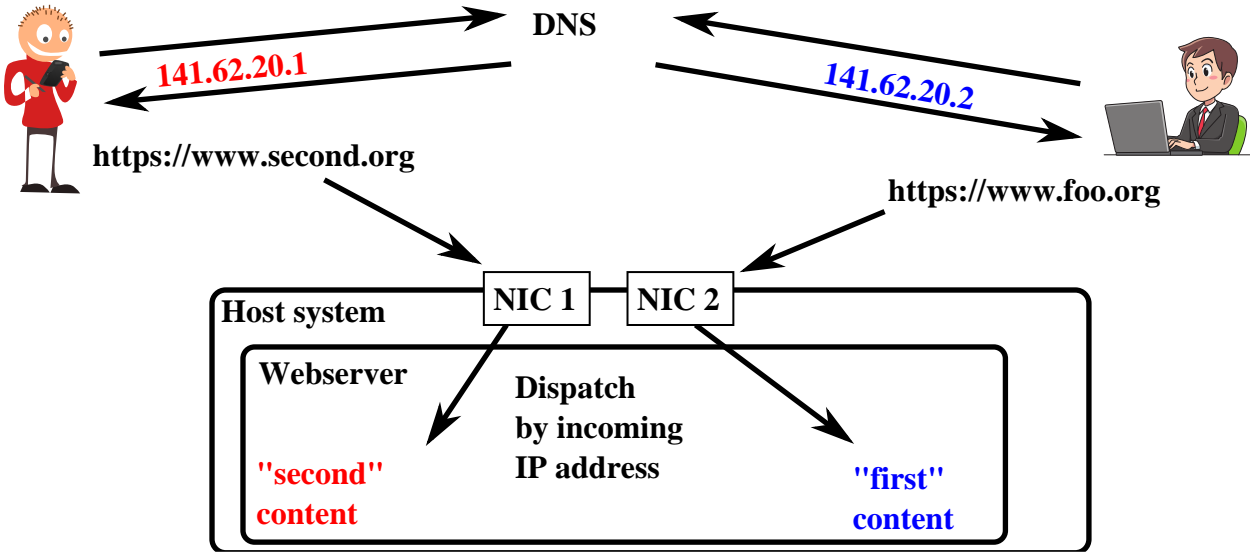

IP based, pros / cons

- Host system: One IP per site to serve
- Pro: TLS handshake without SNI.
Supporting older clients.
- Downside:
 - IP address waste
 - Host system NIC configuration required

Name based virtual hosting



<https://www.second.org>

Name based virtual hosting



DNS

<https://www.second.org>

Name based virtual hosting

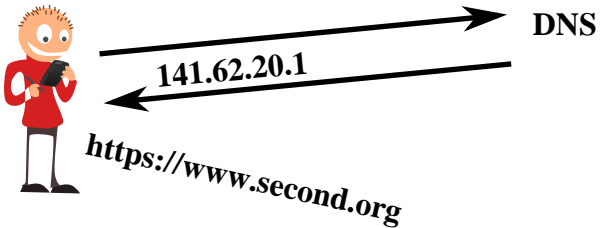

Name based virtual hosting

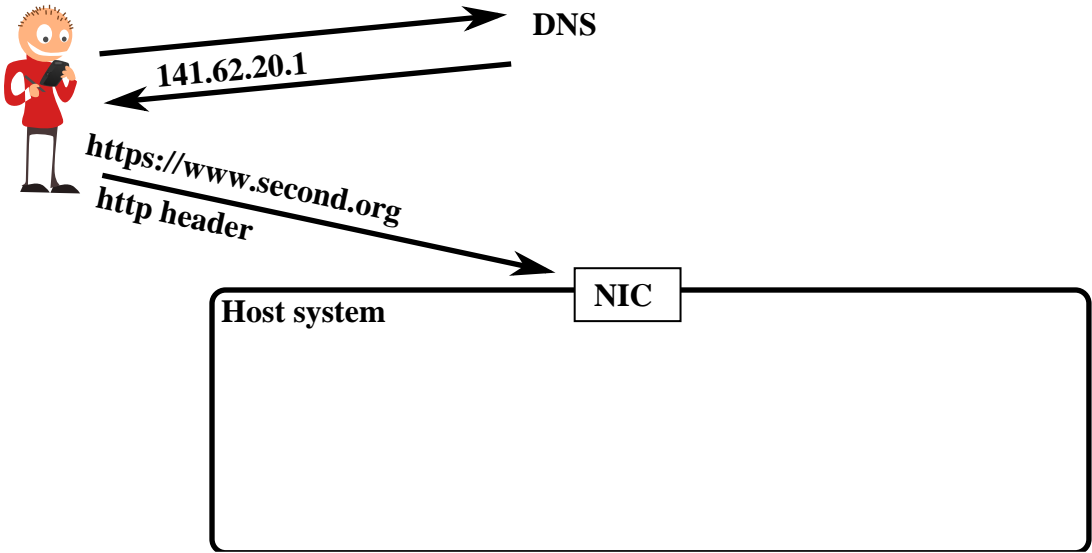

Name based virtual hosting

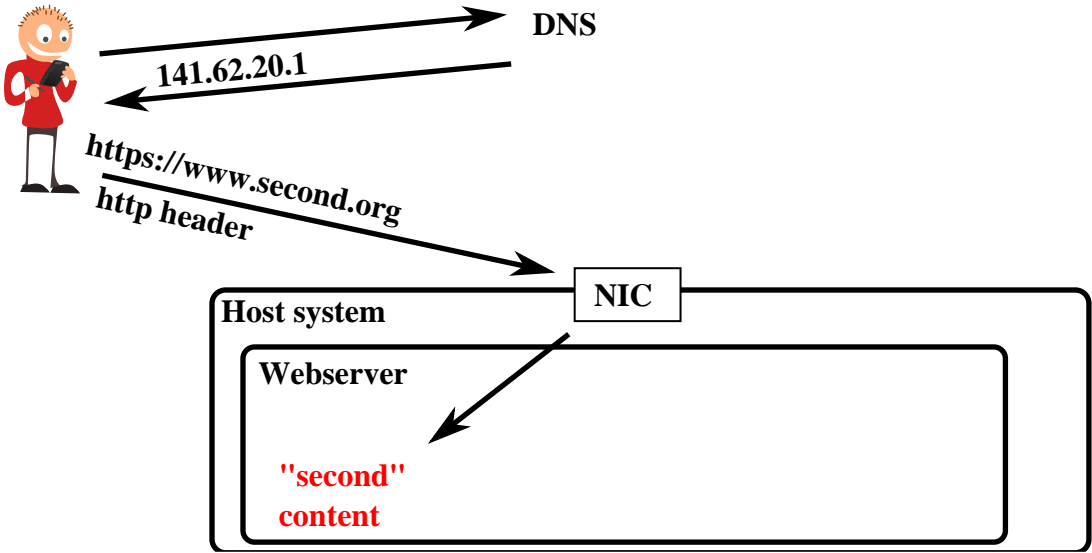

Name based virtual hosting

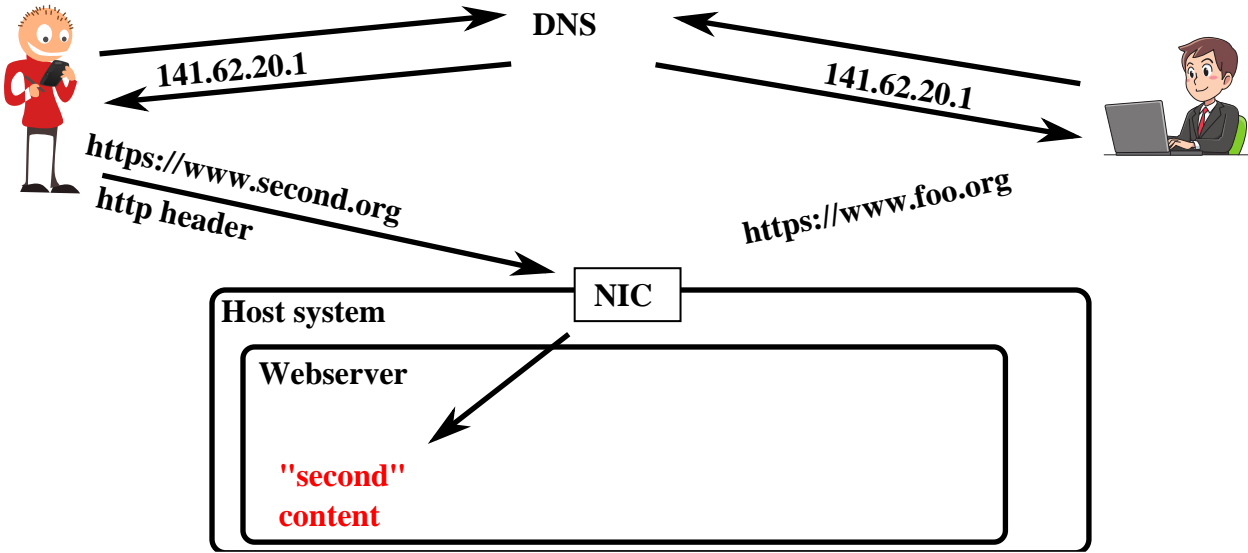

Name based virtual hosting

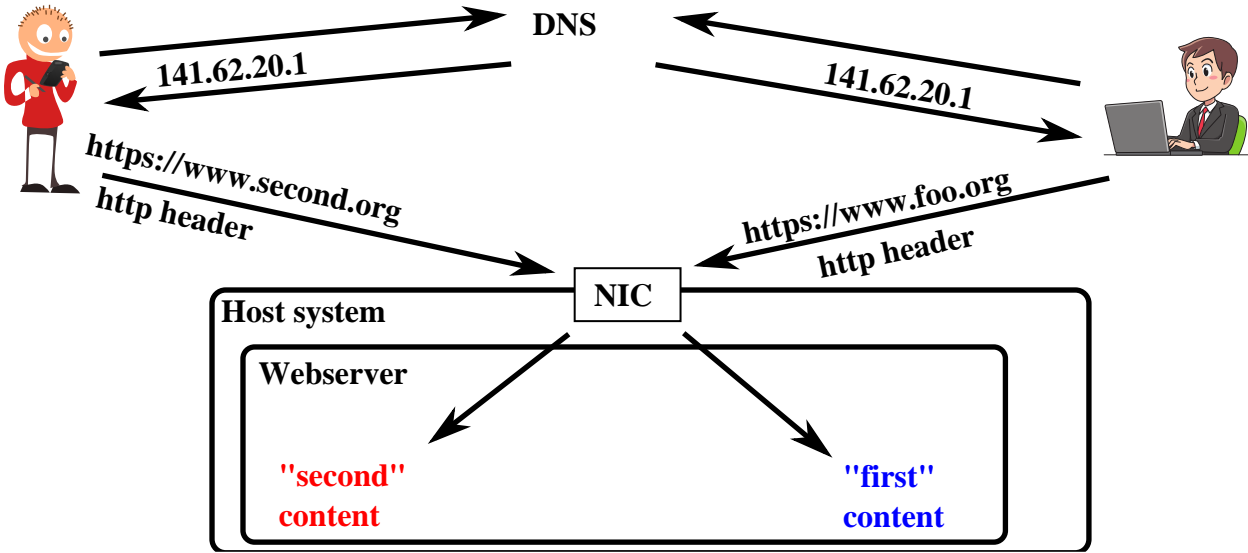

Name based virtual hosting

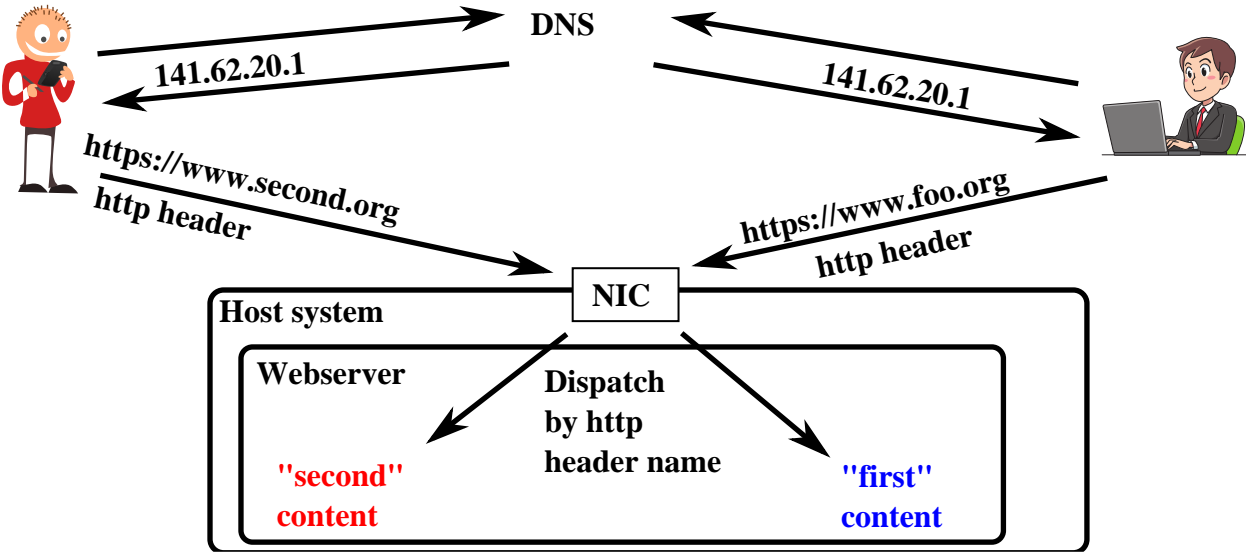

Name based, pros / cons

- Host system: Common IP address
- Pro
 - No IP address waste
 - No Host system NIC configuration required
- Cons: Excluding older non SNI supporting clients.

(Internet Explorer on Windows XP, Android below V. 2.3)

- SNI allows for eavesdropping requested site's name.

LDAP backed authentication

<https://www.my.org>



LDAP backed authentication

https://www.my.org

uid=diana



Webservice



LDAP backed authentication

https://www.my.org

uid=diana



LDAP

bind

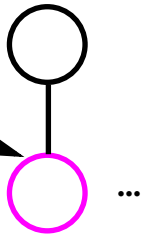

objectClass: posixAccount
uid:diana
userPassword: ...

LDAP backed authentication

https://www.my.org

uid=diana



LDAP

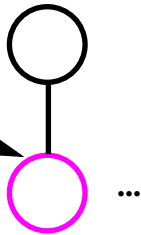

bind

success or

failure

objectClass: posixAccount
uid:diana
userPassword: ...

LDAP backed authentication

https://www.my.org

uid=diana

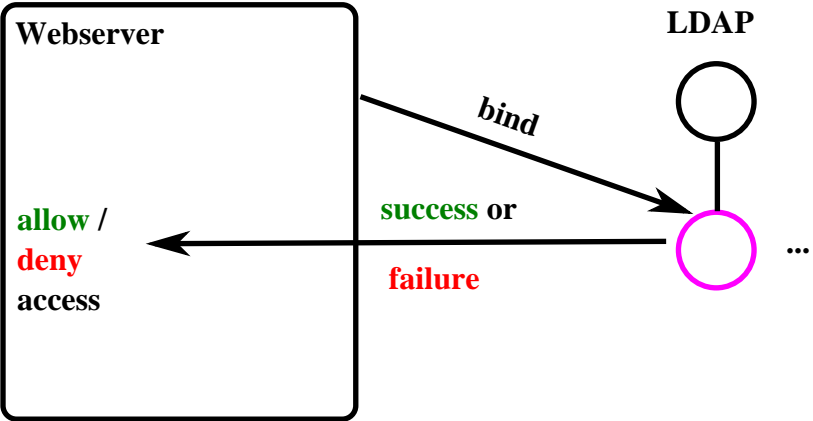

objectClass: posixAccount
uid:diana
userPassword: ...

PHP FPM server



PHP FPM server

<https://www.my.org/index.php>

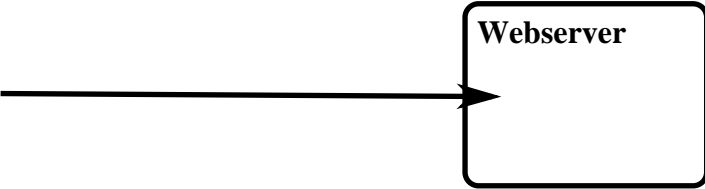

PHP FPM server

<https://www.my.org/index.php>

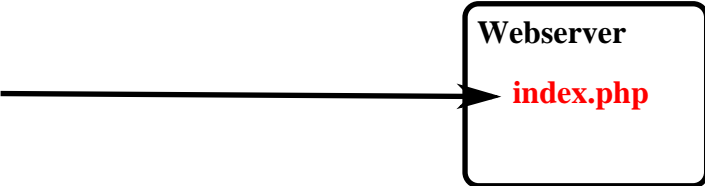

PHP FPM server

<https://www.my.org/index.php>

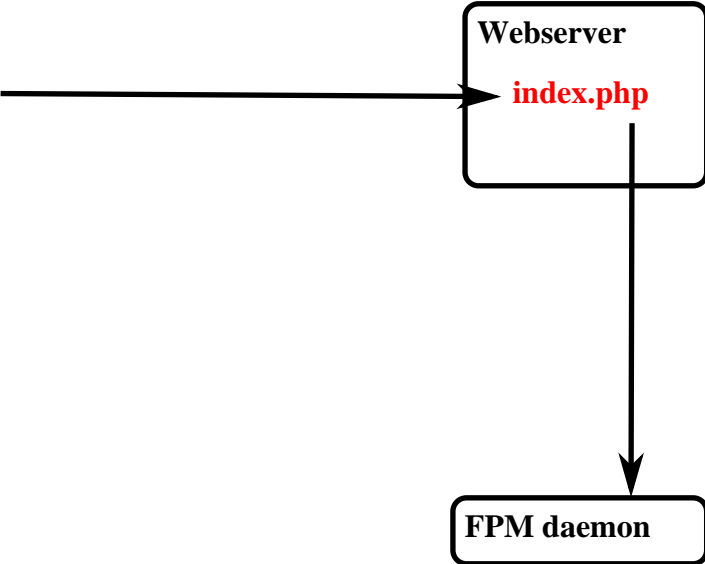

PHP FPM server

<https://www.my.org/index.php>

